

HYUNDAI
POWER PRODUCTS

GASOLINE LAWNMOWER

HTDT512RP

ORIGINAL INSTRUCTIONS

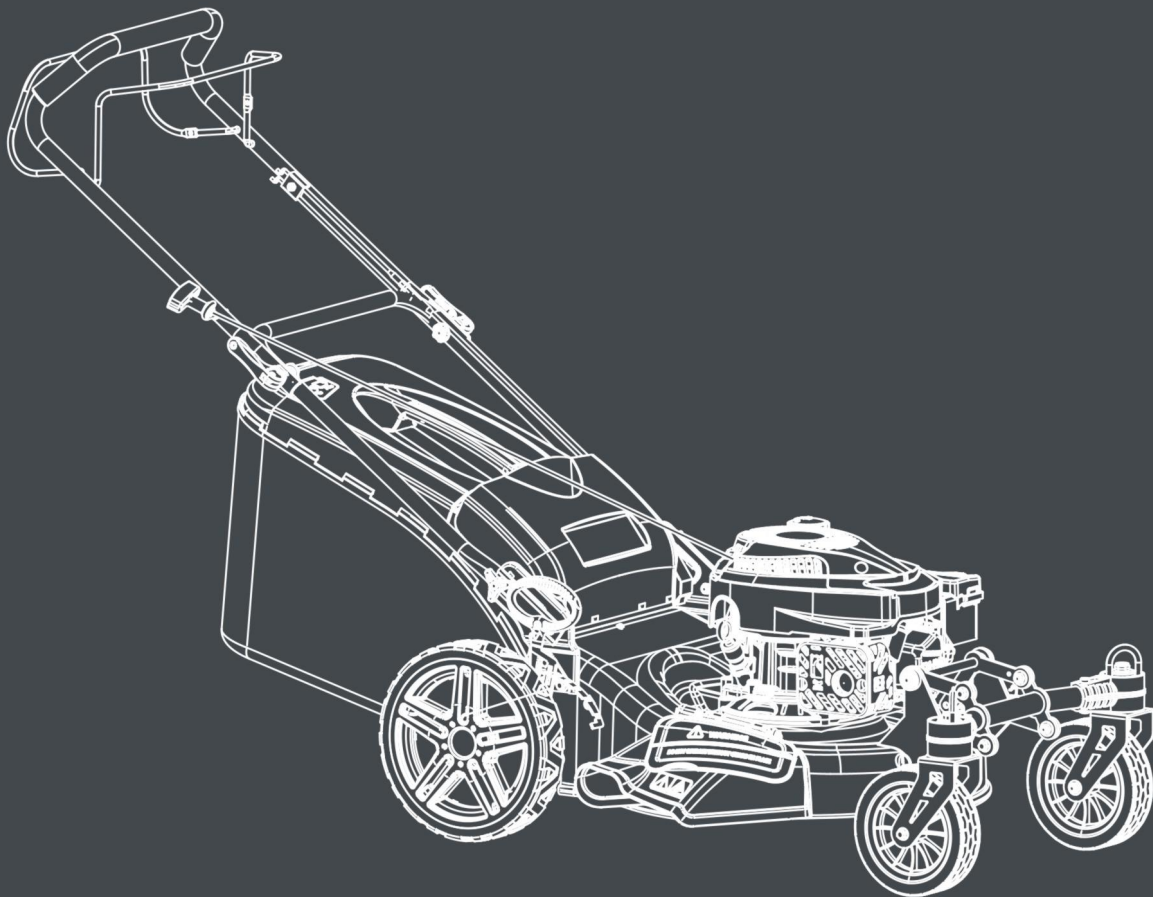

Read the instruction manual carefully before using the mower!

1. SAFETY INSTRUCTIONS

Instructions

- Read the instructions carefully. Be familiar with the controls and proper use of the equipment.
- Never allow children to use this mower. If the mower is given to another person, also give this manual. Also make sure that this person uses this device only after receiving the necessary instructions. Local laws may restrict the age of the user.
- Never mow while people, especially children, or animals are nearby.
- Keep in mind that the operator or user is responsible for accidents or risks that may occur to other persons or their properties.
- If necessary, have training with an experienced person in order to use in a safe way this tool.

Preparation

- During mowing, always wear slip-resistant foot protection and long pants. Do not use the equipment barefoot or wearing sandals open.
- Wear personal protective equipment including at least: clothes of protection, gloves, foot protection, mask, ocular and hearing protection
- Carefully inspect the area where equipment and remove all foreign objects such as stones, toys, sticks and wires.
- **WARNING** - Gasoline is extremely flammable.
 - Add fuel before starting. Do not remove the fuel tank cap while the machine is running or when it is hot.
 - If the fuel has spilled or leaked, do not attempt to start the machine but move the machine away from the leakage area and avoid creating a source of ignition until the gasoline vapours have dissipated.
 - Refuel only outside and do not smoke during refuelling.
 - Store fuel in tanks specifically designated for this purpose.
 - Replace the fuel tank or the defective gasoline plug securely.
- Replace defective mufflers.
- Before use, always inspect visually that the blades, blade assembly and blade lock are not worn or damaged. Replace blades and blade assemblies that are not in good condition to maintain balance. Always use recommended blades. Contact the manufacturer or your dealer in order to have a list of recommended blades. Non-recommended blades can give a risk of malfunctions, injuries and accidents.
- The blades must be balanced to ensure proper operation and to be able to work safely.

Operation

- Do not use the machine in a confined space or hazardous carbon monoxide emissions can be collected.
- Mow only under daylight or under good artificial light. Always have a good visibility.
- Avoid using the equipment on greasy grass, where possible.
- Always be sure of your walking on the slopes.
- Walk, never run.
- For lawn mowers, mow across slopes, never from top to bottom.
- Exercise extreme caution when changing direction on slopes.
- Stop the blades if the mower is to be tilted during transport when crossing surfaces other than grass, and when transporting the mower due to the area to be mowed.
- Do not mow on steep slopes.
- Use extreme caution when tipping or pulling the mower towards you.
- Never use the mower with defective guards, or without safety devices such as baffles and or collection bins, which are not in place.
- Do not change the motor configuration or increase the speed.
- For starting, disengage all blades, the gears must be in neutral, the traction control lever must be released. Set foot well away from the blades.
- Before starting the engine, carefully read and understand all instructions.
- Do not tilt the mower when starting the machine or turn on the engine, unless the mower needs to be tilted for starting. In this case, do not tilt it more than absolutely necessary and lift only the part that is furthest away from the user.
- Do not start the machine by standing in front of the ejection
- Do not place hands or feet near or under rotating parts. Keep clear the mouth of the grass extractor.
- Never take or carry the mower while the machine is running.
- Stop the machine and remove the ignition key, disconnect the spark plug from the spark plug:
 - Before cleaning or unclogging the grass extractor.
 - Before checking, cleaning, and working on the mower.
 - After hitting an object. Inspect the mower for damage and repair before re-using the mower.
 - If the mower begins to vibrate abnormally, stop the engine immediately and check according to previous recommendations.
- The controls must be always checked if they are functioning correctly. In case of malfunction, do not use the tool and bring to a service agent for inspection.

- Stop the engine immediately:
 - Every time you leave the tool alone and the working area
 - Before refuelling.
- When the tool is stopped, park it in a safe place.
- Move slowly when moving.
- The lawnmower should not be used in slopes and near drop-offs, ditches or embankments; if the tool must be used in these kinds of emplacements, take an extreme precaution and operate carefully the tool.
- The lawnmower safety systems or features shall not be tampered with or disabled;
- The operator should not alter or tamper with any sealed adjustments for the engine speed control.

Maintenance and storage

- Check and tighten all bolts and screws to ensure that the equipment is in safe operating condition.
- Never keep the mower with gasoline in the tank in a building or vapours can cause a bright flame or spark.
- Allow the machine to cool before storing it in an enclosed area.
- To reduce the risk of fire, keep the machine clean without grass, without grease, the muffler and the engine cools, and empty the fuel tank.
- Check the grass catcher frequently, its condition or deterioration.
- Replace worn and damaged parts for safety.
- If the fuel tank is to be drained, it must be made outdoors.

Special safety instructions

- Always use the mower with its pick-up bag and / or deflector in the intended position.
- Switch off the engine before emptying the pick-up bag or before changing the cutting height.
- While the engine is running, never put your hands or feet under the mower or under the grass ejection area.
- Before mowing, remove all foreign objects from the grass that can be propelled by the machine.
- Keep children and pets at a safe distance while using the mower.
- Never lift the mower when the engine starts.
- Alcohol, drug, as well as illness, fever and fatigue affect your ability to respond. Do not use power tools in such circumstances.
- Never change the rated speed of the motor.
- Never lift or carry the tool while the engine is running.
- Before starting the engine, release the drawbar.
- Before mowing, install the collection bag in its intended position.
- Do not use the mower in the event of rain or when the grass is wet.
- Never lift the rear of the mower when starting the engine and never place your hands or feet under the mower deck or in the rear ejection port while the engine is running.
- Turn off the engine and remove the spark plug cap in the following cases:
 - Before operating under the mower deck or near the ejection opening.
 - Before any maintenance, repair or verification.
 - Before transporting, lifting or storing the mower.
 - If you leave the mower unattended or change the cutting height.
 - To remove and empty the collection bag.
- After striking a foreign object, turn off the engine and carefully inspect the mower for damage. Take the lawnmower to an authorized service center for repair if necessary.
- If the mower vibrates abnormally, try to understand the reason and bring your lawnmower to an authorized repair center.
- Regularly check that the bolts, nuts and screws are properly tightened for safe use of the mower.
- Do not use the tool where there is a risk of lighting.
- Use the tool on daylight or under a good lighting. Always keep bystanders away.
- Warning: Take an extreme precaution when operating the lawnmower in slopes and near drop-offs, ditches or embankments; always be sure of your footing and stay in alert.
- the lawnmower safety systems or features shall not be tampered with or disabled;
- the operator should not alter or tamper with any sealed adjustments for the engine speed control;
- The operator must have, before using the tool for the first time, an adequate training with an experienced people.
- Warning: do not use of the unit while being tired, ill or under influence of alcohol or other drugs;
- Park safely the tool before leave it. The tool must be switched off.
- The lawnmower shall not be operated without either the entire grass catcher or self-closing discharge opening guard in place;
- Warning: be careful about exhaust gas. Do not inhale them.
- Wear adequate clothing such as long trousers and a protective equipment: slip-resistant foot protection, hearing protection, eyes protection and gloves.
- To avoid health issues, limit the time of operation. Take enough rest. Exposure to noise and vibrate can have bas consequences on health.
- WARNING: There is a danger about moving blade assemblies. Always handle blades when they are in a complete

stop and wear protective gloves.

Fuel Handling

Use caution when handling fuels. They are flammable and the vapours are explosive.
 Use only an approved container.
 Never remove the fuel cap or add fuel while the machine is on. Turn off the unit and allow the engine and exhaust components to cool down before refuelling.
 Do not smoke.
 Never refuel inside a room.
 Never store the tool and the fuel tank indoors where there is a naked flame, such as near a water heater.
 If fuel has spilled, do not attempt to start the machine, but move it away from the spill before starting to use it. Please clean up any spills.
 Replace and tighten the fuel tank cap after refuelling.
 Follow strictly the instructions in this manual for filling the tool with fuel.









During maintenance and storage



Switch off the tool and wait until it stops completely. Make sure that all moving parts are stopped.
 Allow the machine to cool before performing inspection, adjustments, maintenance, servicing and storage.
 Store the tool where fuel vapour will not reach a flame or spark.
 The transport of the tool must be secured in order to avoid fuel spillage, accidents and injuries.

Residual risks

Even if you use this product in compliance with all safety requirements, the potential risks of injury and damage remain. The following hazards may arise in the structure and design of this product:
 There are risks of injury and property damage due to attachments or broken the sudden impact of hidden objects when using cutting.
 There are risks of injuries and accidents caused by flying objects.
 Prolonged use of this product exposes the operator to vibrations and can produce so-called "white finger" disease. To reduce the risk, wear gloves and keep your hands warm.
 If any of the symptoms of "white finger syndrome" occur, seek immediate medical attention.
 Symptoms of "white finger" include numbness, loss of sensitivity, tingling, pain, loss of strength, colour changes or skin condition. These symptoms usually appear on the fingers, hands or wrists. Risk increases at low temperatures.
 A long exposition to noise can affect the health of the operator. A hearing protection must be always used when operating the tool. The operation of the tool must be limited and some rest must be taken between two sessions (e.g. 10min of operation and 20min of rest).

Symbols

 	<p>Warning</p> <p>Read the instruction manual</p>
 	<p>Warning! Risk of projections. Keep bystanders away</p>
   	<p>Remove the ignition cable before all maintenance work, and read the instructions for use.</p> <p>Warning - Moving blades. Keep hands and feet away when the machine is operated.</p>

	<p>Stop the machine before removing any foreign objects from the working area.</p> <p>Never mow while people, especially children, or animals are nearby.</p>
	<p>Guarantee sound power level</p>

2. Intended use

This device is only for lawn mowing grass in the domestic area. The device is designed for domestic use. It is not intended for continuous professional use. Any other use that is not expressly permitted in this manual may result in damage to the device and constitute a serious danger to the user.

This device is designed for use by adults. Children and those unfamiliar with this manual should not use this device. The user is responsible for accidents or damage caused to people or their property. The manufacturer is not liable for damage caused by improper use or improper handling.

3. Description



4. Technical data

Model	HTDT512RP
Engine displacement	170.1 cm ³
Power	2.5 kW
Engine speed	2900/min
Cutting width	51 cm
Adjustable cutting height	6 positions
Grass collection capacities	75L
weight	34kg
Guaranteed Sound Power Level	98dB
Sound pressure level (LpA)	85,5 dB (A); K _{WA} =3 dB (A)
Sound power level (LwA)	96.68dB (A); K _{WA} =1.14 dB
Vibration value Uncertainty	Max 11.92m/s ² ; K=1,5 m/s ²

5. ASSEMBLY

Handle

1. Remove the screws and nuts on the base of the tool
2. Remove the protective padding located on the lower bar.
3. Install the lower bar on the base of the tool and secure it with the screws and nuts.
4. Unfold the handle carefully so as not to pinch or damage the control cables.
5. Raise the handles until the lower handle section locks into the mowing position. If necessary, turn the nut on the handle to lock the handle.



Adjust front wheels

The lawn mower is extremely flexible and maneuverable thanks to the special construction of the front wheels. These are to be adjusted according to the specific situation as follows:

1. The alignment of the wheel is fixed once the clamping brackets snap into place. If the wheel is desired in another running direction, lift clamping bracket to release it. Bring wheel into new position and clamping brackets snaps into place once again.
2. Should the front wheels remain able to move freely, lift the clamping brackets (1) and do not place them in the opening, but rather set them on the plate beside it.

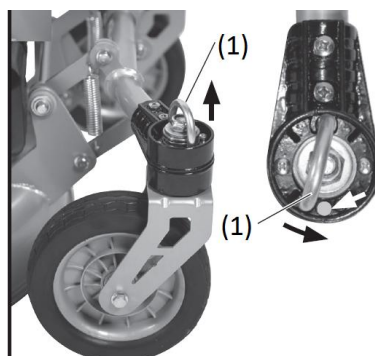

Instruction for grass bag assembly

Before using the grass catcher, the side discharge must be removed.

If the grass bag is delivered unassembled: Pull plastic loops over basket rods.



Open the flap then Install the grass catcher on the hook on the rear of the tool. Release the flap.

Disassemble the grass catcher

Lift the flap and remove the grass catcher.

Side discharge

Before using the side grass discharge, the grass collection basket removed.

- Unlock the flap of the side discharge
- Lift the cover.
- Hook the side discharge. Release the flap.



Mulching kit

Before using the mulching kit, the lateral discharge must be removed.

Assembly

- Remove the grass catcher if installed.
- Lift the flap.
- Fully insert the mulching kit at the back of the tool.
- Press the kit to lock it in place.



Disassembly

- Lift the flap.
- Press the center of the mulching kit firmly.
- Hold and pull the handle to remove the mulching kit.

ADJUST CUTTING HEIGHT

- Pull the lever outward and push it to the desired position.
- Press the lever inward again.

6. FILLING FUEL TANK

a. Filling tank

WARNING! Gasoline is extremely flammable.

Store fuel in specially designed cans for this purpose.

Fill the fuel tank only outdoors and before starting the engine. Do not smoke when filling the fuel tank or handling fuel.

Never open the fuel tank cap and never add fuel while the engine is running or when it is hot.

If fuel has spilled, do not start the engine any further, move the tool away from where the fuel has been spilled, and be careful not to create a spark or flame until the fuel vapors have dissipated.

Fully close all fuel tank and fuel canisters.

Before tilting the mower to maintain the blade or drain the oil, empty the fuel tank.

WARNING: Never fill the fuel tank indoors, while the engine is running, or before the engine has cooled down for at least 15 minutes after use.

CAUTION: Do not use unapproved gasoline, such as E15 and E85. Do not mix the oil with gasoline or modify the engine to operate with alternative fuels. The use of unapproved fuels will damage the engine parts and will void the engine warranty. To protect the fuel system from scale formation, add a fuel stabilizer to the fuel. All fuels are not identical. If startup or performance problems occur, change supplier or fuel brand.

Fuel must meet the following criteria:

- Clean, new and lead-free gasoline.
- A minimum octane rating of 87/87 AKI (91 RON). For use at high altitudes, see below
- A gasoline containing up to 10% ethanol is acceptable.
- Remove the fuel tank cap. Add fuel.
- Close the fuel tank with the cap.

Do not overfill. Wipe off any fuel that has overflowed before starting the engine.

a. Engine oil

Recommended oil: We recommend the use of high quality detergent oil classified such as SAE30. Do not use special additives.

Filling oil tank

- Open the oil tank.
- Fill directly the oil in the tank. Do not overfill.
- Close the oil tank. Wipe any spillage.

Checking the oil level

- Check the oil level when the engine is off and horizontal.
- Remove the plug / dipstick from the oil tank and wipe it off.
- Insert the oil tank plug / dipstick into the tank neck as shown, without screwing it in, and then remove it to check the oil level.
- If the oil level is near or below the lower limit of the dipstick, remove the dipstick and fill the recommended oil reservoir up to the upper limit of the dipstick (bottom edge of the dipstick). Do not overfill.
- Replace the oil tank plug / dipstick.

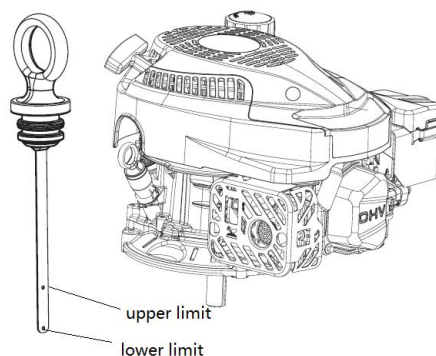

7. OPERATION

Start the device on a safe and flat ground, preferably not in tall grass. Make sure that the cutting tools do not touch objects or the ground.

a. **Start the engine**

- Push 3 times the primer bulb.
- Pull the drive lever bar the operation control bar (control lever) in the direction of the handle and hold it.
- Pull the starter rope.
- If the engine starts, pull back slowly the starter rope.

b. **Stop the engine**

- Release the bars. The engine turns off and the blade is slowed down. Wait until the complete stop of the blade.

c. **Mowing**

- **Self-propeller function**

The self-propelled mechanism engages by pressing the drive lever on the handle and simultaneously pulling the brake lever in the direction of the handle until it clicks. Forward traction by the self-propelled mechanism ceases when you release the drive lever.

To stop the self-propelled mechanism without turning off the engine, release the drive lever a little until the self-propelled mechanism disengages. Pull the drive lever back towards the handle and continue to mow without the self-propelled mechanism.



- **Work instructions**

Mow dry grass as much as possible to save grass.

Adjust the cutting height so that the machine is not overworked.

Drive the machine at moderate speed (walking) along the belt as straight as possible. For a perfect mowing result, the strips must always overlap for a few centimetres

Do not back away.

Always work perpendicular to the slopes.

If the blades come into contact with a foreign object, immediately turn off the engine. Wait for the blades to stop turning completely and check that the unit has not been damaged. Only resume work if the unit has not been damaged.

Turn off the appliance when taking long breaks during work and carrying the appliance.

Wait for the blades to stop turning completely.

Clean the appliance after each use as described in the chapter "Cleaning and maintenance".

8. MAINTENANCE AND STORAGE

Carry out maintenance and cleaning work when the engine is off and the spark plug are out. **Risk of injury!**
Allow the tool to cool down before performing any maintenance or cleaning work. The engine elements are hot.
Risk of burns!
Lack and improper maintenance will reduce the lifetime of the tool and can bring accidents.
Wear gloves when handling the blades.

Cleaning and general maintenance task

Carefully clean the machines with water after each cut; remove the grass debris and mud accumulated inside the chassis to avoid their drying and thus making the next start-up difficult

The paintwork on the inside of the chassis may peel off in time due to the abrasive action of the cut grass; in this case, intervene promptly by touching up the paintwork using a rustproof paint to prevent the formation of rust that would lead to corrosion of the metal.

Remove the transmission casing by removing the screws and clean around the transmission and drive belts with a brush or compressed air once or twice a year.

Once every season, the wheels should be cleaned. Remove the wheels to clean them.

Changing blades

To replace the blade, undo the screw. Empty the oil tank before removing the blade. Wear gloves when handle the blades.

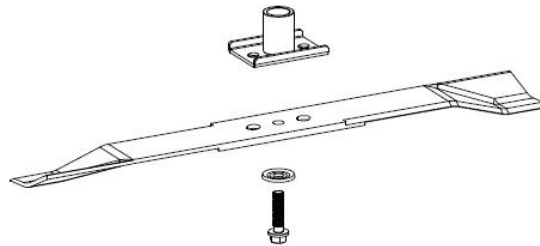

Changing the Oil

Have a container ready to catch the oil and remove the drain plug. We should incline machine to make sure all the oil could be go out. Once the oil has been emptied, replace the drain plug making sure that the washer is in place and wipe clean any spillages.

Refill with SAE30 oil. Do not overfill.

Start the engine and allow it to run briefly. Stop the engine, wait one minute and check the oil level. Top up if necessary.

Spark Plug

Once the engine has cooled, remove the spark plug. Clean the plug with a wire brush. Using a feeler gauge set the gap to 0.7-0.8mm. Refit the spark plug taking care not to over tighten.

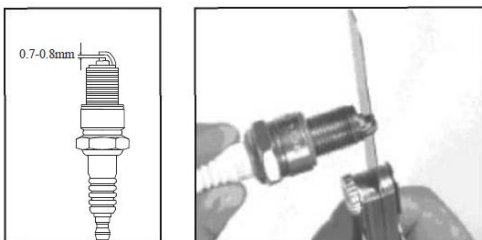

Air Filter

Unclip the air filter cover and remove the sponge filter element. To avoid objects falling into the air intake, replace the air filter cover.

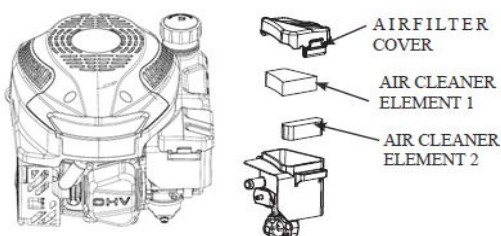

9. MAINTENANCE SCHEDULE

SERVICE	Before	After	After 5 h	After 8 h	After 50 h	Once a year
	Mowing					
check and tighten nuts, bolts and screws	✓					
Check the oil / fuel level and refill oil / fuel if necessary	✓			✓		
Clean control elements / area around sound insulation		✓		✓		
Change the engine oil			✓		✓	✓
Exchange air filters						✓
Clean / adjust & replace spark plugs				✓		✓
Control the sound insulation and the spark screen					✓	✓
Clean the air cooling system						✓

10. DECLARATION OF CONFORMITY



Builder SAS

ZI, 32 rue Aristide Bergès – 31270 Cugnaux - France

Tel: +33 (0)5.34.502.502 Fax: +33 (0)5.34.502.503

Declares that the machines:

LAWN MOWER PETROL

Model: HTDT512RP

Serial No.: 20210104187-20210104436/ 20210106325-20210106444

The people name holding the technical file: Mr. Olivier Patriarca

Have been designed in compliance with the following standards:

EN ISO 5395-1 :2013+A1 :2018

EN ISO 5395-2:2013+A1:2016+A2:2017

EN ISO 14982: 2009

And in accordance with the following directives:

Directive Machine 2006/42/EC

Directive EMC 2014/30/EU

Noise Directive 2000/14/EC Annex V & Directive 2005/88/EC

Notified body 0197

TÜV Rheinland LGA Products GmbH - Tillystraße 2 - 90431 Nürnberg

Emission directive (UE) 2016/1628 & 2018/989/EU

Guaranteed Sound Power Level	98 dB(A)
Measured sound power level	L _{WA} : 96.68 dB (A); K _{WA} =1.14dB

Philippe MARIE / PDG

Cugnaux, 15/20/2020

11. WARRANTY

HYUNDAI

WARRANTY

The manufacturer guarantees the product against defects in material and workmanship for a period of 2 years from the date of the original purchase. The warranty only applies if the product is for household use. The warranty does not cover breakdowns due to normal wear and tear.

The manufacturer agrees to replace parts identified as defective by the designated distributor. The manufacturer does not accept responsibility for the replacement of the machine, in whole or in part, and/or ensuing damage.

The warranty does not cover breakdowns due to:

- insufficient maintenance.
- abnormal assembly, adjustment or operations of the product.
- parts subject to normal wear and tear.

The warranty does not extend to:

- shipping and packaging costs.
- using the tool for a purpose other than that for which it was designed.
- the use and maintenance of the machine done in a manner not described in the user manual.

Due to our policy of continuous product improvement, we reserve the right to alter or change specifications without notice. Consequently, the product may be different from the information contained therein, but a modification will be undertaken without notice if it is recognized as an improvement of the preceding characteristic.

READ THE MANUAL CAREFULLY BEFORE USING THE MACHINE.

When ordering spare parts, please indicate the part number or code, you can find this in the spare parts list in this manual. Keep the purchase receipt; without it, the warranty is invalid. To help you with your product, we invite you to contact us by phone or via our website:

- **+33 (0)9.70.75.30.30**
- **<https://services.swap-europe.com/contact>**

You must create a "ticket" via the web platform.

- Register or create your account.
- Indicate the reference of the tool.
- Choose the subject of your request.
- Describe your problem.
- Attach these files: invoice or sales receipt, photo of the identification plate (serial number), photo of the part you need (for example: pins on the transformer plug which are broken).



12. PRODUCT FAILURE

WHAT TO DO IF MY MACHINE BREAKS DOWN?

If you bought your product in a store:

- a) Empty the fuel tank.
- b) Make sure that your machine is complete with all accessories supplied, and clean! If this is not the case, the repairer will refuse the machine.

Go to the store with the complete machine and with the receipt or invoice.

If you bought your product on a website:

- a) Empty the fuel tank.
- b) Make sure that your machine is complete with all accessories supplied, and clean! If this is not the case, the repairer will refuse the machine.
- c) Create a SWAP-Europe service ticket on the site: <https://services.swap-europe.com> When making the request on SWAP-Europe, you must attach the invoice and the photo of the nameplate (serial number).
- d) Contact the repair station to make sure it is available before dropping off the machine.

Go to the repair station with the complete machine packed, accompanied by the purchase invoice and the station support sheet downloadable after the service request is completed on the SWAP-Europe site

For machines with engine failure from manufacturers BRIGGS & STRATTON, HONDA and RATO, please refer to the following instructions.

Repairs will be done by approved engine manufacturers of these manufacturers, see their site:

- <http://www.briggsandstratton.com/eu/fr>
- <http://www.honda-engines-eu.com/fr/service-network-page;jsessionid=5EE8456CF39CD572AA2AEEDFD290CDAE>
- <https://www.rato-europe.com/it/service-network>

Please keep your original packaging to allow for after-sales service returns or pack your machine with a similar cardboard box of the same dimensions.

For any question concerning our after-sales service you can make a request on our website <https://services.swap-europe.com>

Our hotline remains available at +33 (9) 70 75 30 30.



13. WARRANTY EXCLUSIONS

THE WARRANTY DOES NOT COVER:

- Start-up and setting up of the product.
- Damage resulting from normal wear and tear of the product.
- Damage resulting from improper use of the product.
- Damage resulting from assembly or start-up not in accordance with the user manual.
- Breakdowns related to carburetion beyond 90 days and fouling of carburetors.
- Periodic and standard maintenance events.
- Actions of modification and dismantling that directly void the warranty.
- Products whose original authentication marking (brand, serial number) has been degraded, altered or withdrawn.
- Replacement of consumables.
- The use of non-original parts.
- Breakage of parts following impacts or projections.
- Accessories breakdowns.
- Defects and their consequences linked to any external cause.
- Loss of components and loss due to insufficient screwing.
- Cutting components and any damage related to the loosening of parts.
- Overload or overheating.
- Poor power supply quality: faulty voltage, voltage error, etc.
- Damages resulting from the deprivation of enjoyment of the product during the time necessary for repairs and more generally the costs related to the immobilization of the product.
- The costs of a second opinion established by a third party following an estimate by a SWAP-Europe repair station
- The use of a product which would show a defect or a breakage which was not the subject of an immediate report and/or repair with the services of SWAP-Europe.
- Deterioration linked to transport and storage*.
- Launchers beyond 90 days.
- Oil, petrol, grease.
- Damages related to the use of non-compliant fuels or lubricants.

* In accordance with transport legislation, damage related to transport must be declared to carriers within 48 hours maximum after observation by registered letter with acknowledgement of receipt.

This document is a supplement to your notice, a non-exhaustive list.

Attention: all orders must be checked in the presence of the delivery person. In case of refusal by the delivery person, it you must simply refuse the delivery and notify your refusal.

Reminder: the reserves do not exclude the notification by registered letter with acknowledgement within 72 hours.

Information:

Thermal devices must be wintered each season (service available on the SWAP-Europe site). Batteries must be charged before being stored.

HYUNDAI

POWER PRODUCTS

For Inquiries, please contact:

BUILDER SAS

32, rue Aristide Bergès Z1 31270 Cugnaux, France

Tél. : +33 (0) 5.34.502.502 Fax : +33 (0) 5.34.502.503

<http://www.hyundai-power-fr.com/>

Fabriqué en République Populaire de Chine (PRC)